



Ph: 1300 214 015
 info@unisonjoints.com.au
 2/282 New Cleveland Rd
 Tingalpa, Queensland 4173



UNISON JOINTS Pty. Ltd.

Model:

Project:

Si270TL
 (SUACT270L)

Material:

Anodised Aluminium
Do Not Scale

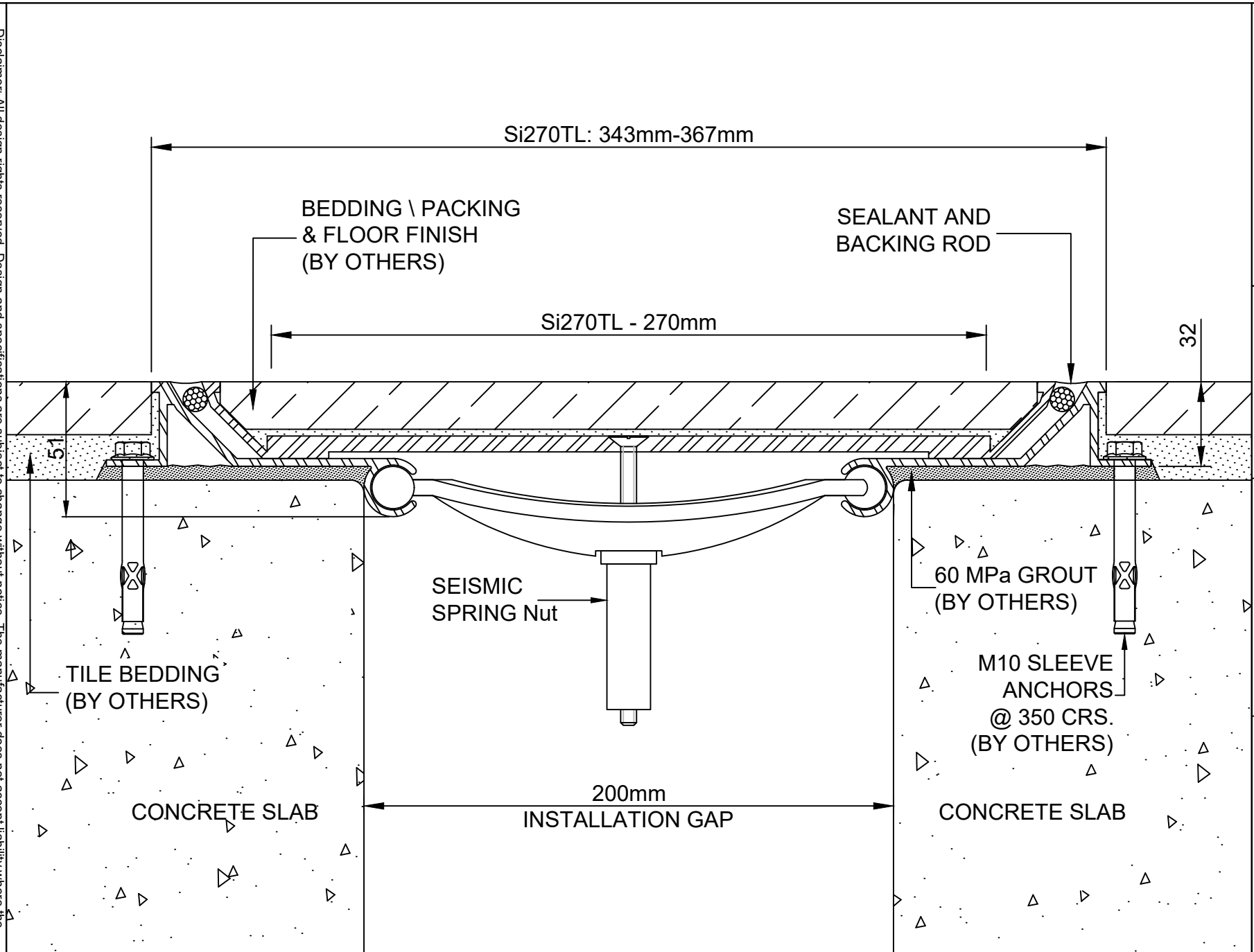

Disclaimer: All design rights reserved. Design and specifications are subject to change without notice. The manufacturer does not accept liability where the material on these pages is misconceived, exploited or lacks conformity. The intention of this information is to provide a reasonable description of products, procedures and capabilities. Rev.2